



User guide

Receiver-In-Ear hearing aids

Hearing instrument type designations for models included in this user guide are: **BRIE**, FCC ID: X26BRIE, IC: 6941C-BRIE; **VE312**, FCC ID: X26VE312, IC: 6941C-VE312; **MRIE**, FCCID: X26MRIE, IC 6941C-MRIE. Please see page 7 for list of models referring to all types.

Statement:

This device complies with part 15 of the FCC rules and ISED rules.

Operation is subject to the following two conditions: (1) this device may not cause harmful interference, and (2) this device must accept any interference received, including interference that may cause undesired operation.

Note: This equipment has been tested and found to comply with the limits for a Class B digital device, pursuant to part 15 of the FCC Rules and ISED rules. These limits are designed to provide reasonable protection against harmful interference in a residential installation. This equipment generates, uses and can radiate radio frequency energy and, if not installed and used in accordance with the instructions, may cause harmful interference to radio communications. However, there is no guarantee that interference will not occur in a particular installation. If this equipment does cause harmful interference to radio or television reception, which can be determined by turning the equipment off and on, the user is encouraged to try to correct the interference by one or more of the following measures:

- Reorient or relocate the receiving antenna.
- Increase the separation between the equipment and receiver.
- Connect the equipment into an outlet on a circuit different from the one in which the receiver is connected.
- Consult the dealer or an experienced radio/TV technician for help.

Changes or modifications can void the user's authority to operate the equipment.

Intended use

Generic air-conduction hearing instruments are wearable sound-amplifying devices intended to compensate for impaired hearing. The fundamental operating principle of hearing instruments is to receive, amplify, and transfer sound to the ear drum of a hearing impaired person.

The products are in compliance with the following regulatory requirements:

- In EU: the device conforms to the Essential Requirements according to Annex I of Council Directive 93/42/EEC for medical devices (MDD).
- Hereby, GN ReSound A/S declares that the radio equipment types BRIE, VE312 and MRIE are in compliance with Directive 2014/53/EU. The full text of the EU declaration of conformity is available at the following internet address: www.declarations.resound.com
- In US: FCC CFR 47 Part 15, subpart C.
- Other identified applicable international regulatory requirements in countries outside the US. Please refer to local country requirements for these areas.
- In Canada: these hearing instruments are certified under the rules of ISED.
- Japanese Radio Law and Japanese Telecommunications Business Law Compliance. This device is granted pursuant to the Japanese Radio Law (電波法) and the Japanese telecommunications Business Law (電気通信事業法) This device should not be modified (otherwise the granted designation number will become invalid)
- **Patents**
US 7,593,537 US 8,00,849

Prescription use of a Tinnitus Sound Generator (TSG) hearing instrument

The TSG module should be used as prescribed by your doctor, audiologist or hearing healthcare professional. In order to avoid permanent hearing damages, the maximum daily usage depends on the level of the generated sound.

Should you develop any side effects from using the sound generator, such as dizziness, nausea, headaches, perceived decrease in auditory function or increase in tinnitus perception, you should discontinue use of sound generator and seek medical evaluation.

The target population is primarily the adult population over 18 years of age. This product may also be used with children 5 years of age or older. However, children and physically or mentally challenged users will require training by a doctor, audiologist, hearing healthcare professional or the guardian for the insertion and removal of the hearing instrument containing the TSG module.

Important notice for prospective sound generator users

A tinnitus sound generator is an electronic device intended to generate noise of sufficient intensity and bandwidth to mask internal noises. It is also used as an aid in hearing external noises and speech.

Good health practice requires that a person with a tinnitus condition have a medical evaluation by a licensed physician (preferably a physician who specializes in diseases of the ear) before using a sound generator. Licensed physicians who specialize in diseases of the ear are often referred to as otolaryngologists, otologists or otorhinolaryngologists.

The purpose of medical evaluation is to assure that all medically treatable conditions that may affect tinnitus are identified and treated before the sound generator instrument is used. The sound generator instrument

is a tool to generate sounds to be used with appropriate counselling and/or in a tinnitus management programme to relieve patients suffering from tinnitus.

Introduction

Congratulations on the purchase of your new hearing instruments. ReSound's innovative sound technology and design, combined with the customized device programming selected by your hearing care professional, will make hearing a more enjoyable experience. Hearing instruments will enable you to hear sounds that you may not have heard in years because of your hearing loss. Practice and a positive attitude are important in learning to use hearing instruments. Your ReSound instruments have been adjusted according to your individual hearing loss and needs. Some people adjust quickly to wearing hearing instruments in their ears and hearing new sounds; other people may need more time.

Please read this manual carefully in order to wholly benefit from the use of your hearing instruments. With proper care, maintenance, and usage, your hearing instruments will aid you in better communication for many years. Ask your hearing care professional if you have any questions.

Hearing instrument model: _____

Model 61: Battery size 312

Model 62: Battery size 13

Model 62: battery size 312

Receiver tube length: _____

Dome size: _____

Left serial number: _____

Right serial number: _____

Mini Receiver In-the-Ear (RIE) hearing instruments of type VE312 with FCC ID: X26VE312, IC number 6941C-VE312 and size 312 battery are available in the following variants:

LS961-DRW, LS761-DRW, LS561-DRW

Receiver-In-the-Ear (RIE) hearing instruments of type BRIE with FCC ID X26BRIE, IC number 6941-BRIE and size 13 battery are available in the following variants:

LS962-DRW, LS762-DRW, LS562-DRW

Receiver-In-the-Ear (RIE) hearing instruments of type MRIE, FCC ID: X26MRIE, IC: 6941C-MRIE. and size 312 battery are available in the following variants:

EY362-DWR

The identification number for the BRIE, MRIE and VE312 device models can be found at location "13" as indicated in the illustrations on page 10 and 11.

Contents

Statement:	2	Telephone use.	20	How to apply domes.	30	Important notice for prospective hearing aid users (US Only)	41
Intended use	3	Listening to radio or TV.	21	Using ReSound hearing instruments with smart phone apps.	31	Children with hearing loss (US Only)	42
Prescription use of a Tinnitus Sound Generator (TSG) hearing instrument	4	Using ReSound Hearing Instruments with iPhone®, iPad®, and iPod touch® (ReSound LiNX ²).	21	General precautions	32	Troubleshooting Guide	44
Important notice for prospective sound generator users.	4	Cellular phones.	21	General warnings	32	Technical data.	48
Introduction.	5	PhoneNow	22	Tinnitus Sound Generator (TSG) module	34	Warranty and repairs	56
Contents	8	Telecoil (optional).	24	User instructions for the TSG module.	34	Temperature test, transport and storage information	56
Getting started	12	Tele-loop systems.	24	Using TSG with smart phone apps.	36		
SmartStart	12	Direct audio input (optional)	24	The scientific concepts that form the basis for the device.	37		
Inserting/Replacing the battery.	12	Connecting/Disconnecting audio boots	25	Technical Specifications	37		
Low battery indicator	13	Care and maintenance	26	TSG warnings	38		
Low battery indicator when paired with wireless accessories only	13	Daily maintenance.	27	TSG precautions.	38		
Sports lock	14	The receiver tube	28	TSG warning to hearing healthcare professionals.	39		
Inserting/Removing hearing instruments.	14	Cleaning the receiver tubes and domes	28	Battery warning information	40		
Program and multi-function buttons	16	Cleaning RIE or molds (does not apply for Ultra Power molds)	28	Hearing instrument expectations	40		
Flight mode.	19	Changing wax guard for receiver tube	29	Warning to hearing aid dispensers (US Only)	41		

1. Receiver tube
2. Receiver Open Dome
3. Receiver Tulip Dome
4. Receiver Power Dome
5. RIE mold
6. Sports lock
7. Battery compartment
8. Receiver
9. Multi-functional push button
10. LP receiver tube
11. MP receiver tube
12. HP receiver tube
13. Model, and serial number (in battery chamber)
14. UP Receiver/Mold
15. Left/Right indicator
16. Direct audio input

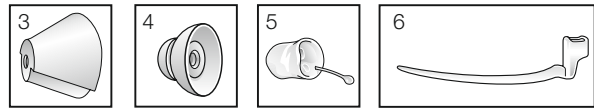

ReSound LINX² 62 models

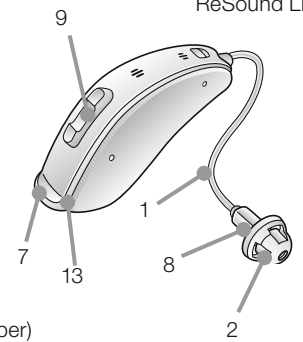

61 model (type VE312)

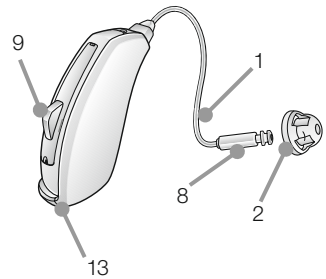

ReSound Enya 62 models

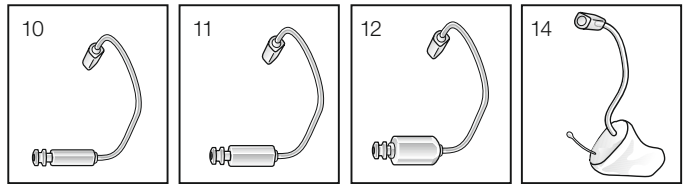
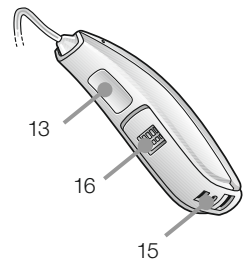
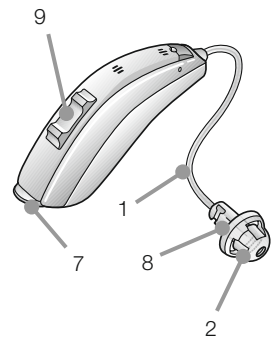

Getting started

On/Off function

1. When the battery door is closed, the hearing instrument turns on, and the default program will be activated.
2. To turn off the hearing instrument, open the battery door. Use your fingernail/tip to pull it open.

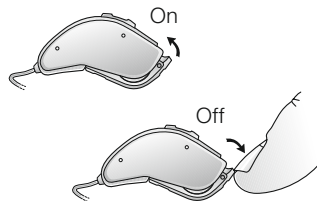

SmartStart

Hearing instruments can be turned on once you have placed them on your ears. If you prefer to turn them on just prior to placing them on your ear, your hearing care professional can activate a function called SmartStart. This function will delay the time in which the hearing instruments turn on after the battery compartment is closed. With SmartStart, a beep will be heard for each second of the delay period.

Inserting/Replacing the battery

1. Open the battery door completely by using your fingernail/tip. Remove the used battery if present.
2. Prepare the new battery (please refer to page 6 for information on appropriate battery type/size for your hearing instrument). Remove the protective foil and wait 2 minutes before inserting the battery into the hearing instrument to allow activation of the battery.
3. Insert the new battery with the positive side in the correct position.
4. Gently close the battery door.

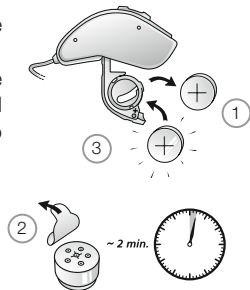

Tip:

1. Always use new Zinc-Air batteries that have a minimum remaining shelf life of one year.
2. Whenever the hearing instruments are not in use, remember to turn them off to avoid unnecessary battery consumption.

Low battery indicator

Your hearing care professional can set your hearing instrument to give an acoustical indication when the battery is reaching its end of life. The hearing instrument will reduce amplification and emit a melody if battery power gets too low. This signal will recur every 15 minutes until the hearing instrument automatically switches off. It is recommended that you keep spare batteries on hand.

Low battery indicator when paired with wireless accessories only

Active usage of the ReSound Unite accessories (Remote Control, Remote Control 2, Phone Clip, Phone Clip+, TV Streamer, TV Streamer 2 and Mini Microphone) requires more battery power from the hearing instruments than when these are working on their own meaning that battery life is highly dependent on the amount of wireless accessory usage. When the battery in the hearing instrument has depleted to a level at which use of the ReSound Unite TV Streamer, TV Streamer 2, Phone Clip, Phone Clip+ and Mini Microphone cannot be supported, the hearing instrument will play two sets of descending tones. After this, your hearing instrument and ReSound Unite Remote Control, Remote Control 2 will continue to work as usual, but you will not be able to use your ReSound Unite TV Streamer, TV Streamer 2, Phone Clip, Phone Clip+ and Mini Microphone. At some point the battery level will not support the remote control either and you will once again hear the descending tones. The hearing instruments will continue to work as usual. Once a new battery is inserted, full operation of the accessories will resume.

Sports lock

The sports lock will be applied or adjusted by your hearing care professional.

Inserting/Removing hearing instruments

Insertion (custom RIE and Ultra Power (UP) molds)

1. Hold the RIE mold between your thumb and index finger and position its sound outlet in your ear canal.
2. Slide the RIE mold all the way into your ear with a gentle, twisting movement.
3. Move the RIE mold up and down and gently press to ensure it is positioned correctly in the ear. Opening and closing your mouth can ease insertion.
4. Make sure the hearing instrument is seated behind the ear.

By experimenting, an easier method may be discovered. With proper insertion, hearing instruments should fit snugly but comfortably. If hearing instruments cause irritation of the ears, contact your hearing care professional.

 Never attempt to modify the shape of the hearing instrument, RIE molds, or tubing yourself.

 **Tip:** It may be helpful to pull the top of your ear back with your opposite hand during insertion to open the ear canal.

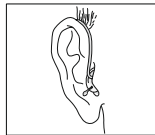

Insertion (domes)

1. Hold the receiver tube where it bends, and gently place the dome into the ear canal. Push the dome far enough into the ear canal so that the receiver tube lies flush with the side of the head.
2. It is important that the tube and the dome fit correctly into your ear.
3. When the dome is placed correctly, you should not be able to see the receiver tube sticking out when facing a mirror.

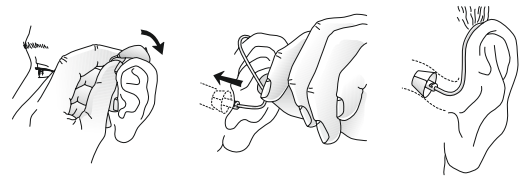

Note: You should never attempt to bend or modify the shape of the receiver tube.

Removal (RIE molds)

1. Grasp the removal string and pull the RIE or UP mold outward.
2. Consult your hearing care professional if you have difficulties removing the hearing instrument.

Removal (domes)

1. Hold the receiver tube with your thumb and forefinger and remove the tube.
2. Consult your hearing care professional if you have difficulties removing the hearing instrument.

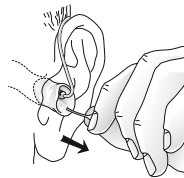

Program and multi-function buttons

If you have a hearing aid with a program button or multi-function button, this will allow you to use up to four different listening programs, each of them suitable for certain situations.

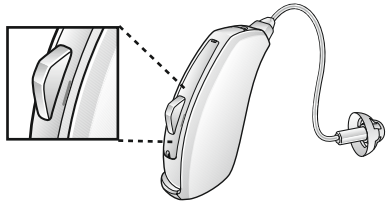

Program button (61 models only)

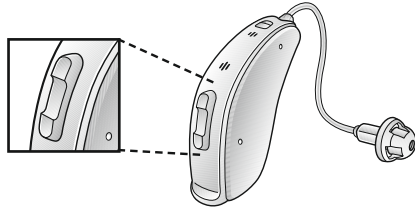

Multi-function button (62 models only)

Your hearing care professional can fill out the following table for you.

Program	Description of when to use
1	
2	
3	
4	

When using the program or multi-function buttons to switch programs, each press will move the instrument to the next program. For example, if it was in program 1 it will switch to program 2, if it was in program 2 it will switch to program 3 etc.

When you close the battery door and switch the instrument on, it will start in program 1. Press the program or multi-function buttons if you want to move to a different listening program.

If you have two hearing instruments with the synchronization function enabled, program changes to one instrument will automatically repeat in the second instrument. When a program change is made in one instrument, you will hear the same amount of confirmation beeps in the second instrument.

Your instrument has a fully automatic volume control. Therefore, it should not be necessary to control the volume manually.

However, in addition to controlling listening programs, the multi-function button (62 models only) provides you with the ability to adjust the amplification to your liking.

If you have two hearing instruments with the synchronization function enabled and you have the multi-function button set for volume control functionality, volume adjustments to one instrument will automatically repeat in the second instrument. When a volume control adjustment is made in one instrument, you will hear a confirmation beep. A beep in the second instrument will follow.

The multi-function button is designed to change the volume or listening programs of the hearing instrument, based on different ways it is pressed.

If necessary, your hearing care practitioner can change these settings and fill in the following table to indicate the new settings:

Multi-function button action	Default setting	New setting
Short press up	Increases volume	
Short press down	Decreases volume	
Long press up (3 seconds)	Changes programs	
Long press down (3 seconds)	Activates streaming	

Flight mode

When boarding a flight or entering an area where RF transmitters are prohibited, wireless functionality must be deactivated, as it is not allowed to radiate radio signals during flights or in otherwise restricted areas.

It is possible to disable wireless operation by opening and closing the battery compartment three times within a ten second period (open-close, open-close, open-close). Your instruments will now be in flight mode.

If the hearing instrument is in flight mode, the hearing instrument must have been operating in flight mode for at least 10 seconds before attempting to enable wireless again. It is possible to re-enable wireless operation by opening and closing the battery door once. 10 seconds after this operation is completed, wireless operation will begin again.



Note: It is important to wait an additional 15 seconds after wireless function resumes before opening and closing the battery compartment again for any reason. If the battery compartment is opened and closed during this 15 second window, flight mode will resume.

Telephone use

If your hearing instruments are fit with a receiver open dome or receiver tulip dome, you can probably use the telephone as you normally would by holding it up to your ear canal opening. If your hearing instruments are fit with a receiver power dome or RIE or UP mold, finding the optimal position for holding a telephone while using a hearing instrument may require practice for some individuals, and one or more of the following suggestions may be helpful.

1. Hold the telephone as you would normally.
2. Hold the telephone towards the top of the ear (closer to where the microphones are located).
3. If whistling occurs, it may take a brief moment of holding the telephone in the same position before the hearing instrument adapts and reduces the feedback.
4. Any whistling may also be decreased by holding the telephone slightly away from the ear.
5. Depending on your individual needs, your hearing care professional may activate a program specifically for telephone use.

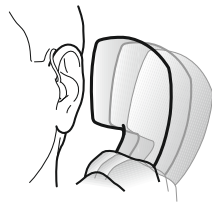

Listening to radio or TV

When listening to the TV or the radio, start out by listening to news commentators since they usually speak clearly, then try other programs.

If you find it difficult to listen to TV or radio, your hearing care professional will be able to give you advice on available wireless accessories to enhance your listening capabilities for TV and radio.

Using ReSound Hearing Instruments with iPhone®, iPad®, and iPod touch® (ReSound LiNX²)

ReSound LiNX² is a Made for iPhone instrument and allows for direct communication and control with an iPhone, iPad, or iPod touch. For assistance in pairing and using these products with your ReSound LiNX² device, please contact your hearing care professional or visit our support site at www.resound.com/linx.

Cellular phones

Your hearing instrument is designed to comply with the most stringent Standards of International Electromagnetic Compatibility. However, not all cell phones are hearing instrument compatible. The varying degree of disturbance can be due to the nature of your particular cellular phone or of your wireless telephony service provider.

If you find it difficult to obtain a good result while using your cellular phone, your hearing care professional will be able to give you advice on available wireless accessories to enhance listening capabilities.

PhoneNow

The PhoneNow function, allows your hearing instrument to switch to an automatic telephone program when a telephone receiver is raised to the ear. When the telephone receiver is removed from the ear, the hearing instrument automatically returns to the previous listening program.

Placement of PhoneNow magnets

Place PhoneNow magnet on your telephone receiver to allow operation of the PhoneNow function. In order to place PhoneNow magnet properly:

1. Clean the telephone receiver thoroughly.
2. Hold the telephone vertically, in a position similar to when making a telephone call.
3. Place the magnets just below the telephone receiver. Make sure not to cover the microphone openings. If necessary, move the magnet to another position to improve ease of use and comfort while speaking.
4. If you are not satisfied with the strength of PhoneNow, you can reposition the PhoneNow magnet or add additional PhoneNow magnets.

PhoneNow usage

Telephones can be used in a normal manner. A short melody will indicate that the PhoneNow feature has automatically switched the hearing instrument to your telephone program. Initially, you may need to move the telephone receiver slightly to find the best position for reliable PhoneNow activation and good hearing on the telephone.

If you have two hearing instruments with the synchronization function enabled, the volume of hearing instrument on the non-phone ear will be turned down.



Only use recommended cleaning agent to clean the telephone prior to placing the magnet on the phone in order to obtain best possible adherence.



PhoneNow warnings

1. Keep magnets out of reach of pets, children and mentally challenged persons. If a magnet is swallowed, please seek advice from a medical practitioner.
2. The magnet may affect some medical devices or electronic systems. The manufacturer of any magnetically sensitive devices (e.g. pacemakers) should advise you regarding appropriate safety precautions when using your hearing instrument and magnet in close proximity to the medical device or electronic system in question. If the manufacturer cannot issue a statement, we recommend keeping the magnet or a telephone equipped with the magnet 30 cm (12") away from magnetically sensitive devices (e.g. pacemakers).



PhoneNow precautions

1. High distortion during dialing or phoning may mean that the magnet is not in the optimal position relative to the telephone receiver. To avoid the issue, please move the magnet to another place on the telephone receiver.
2. Only use magnets supplied by ReSound.

Telecoil (optional)

If equipped, a telecoil can be activated by your hearing care professional and accessed through one of the additional programs. A telecoil picks up a telephone's magnetic signal and converts it to sound. An optional telephone program may help to improve speech understanding on the telephone. When using a telecoil program, the receiver of the telephone may need to be held closer to the hearing instrument. The handset of the telephone may need to be moved to slightly different positions in order to find the best reception.

Tele-loop systems

Many places, such as theatres, houses of worship, and schools are equipped with tele-loop systems. When using a telecoil program with tele-loop systems, sound is picked up directly and may improve speech understanding. If there is no sound from the hearing instruments in a tele-loop system and with a telecoil program activated, the tele-loop system may not be turned on or is not operating correctly. If a facility is not equipped with a tele-loop system, sitting as close as possible to the front may be helpful.

Direct audio input (optional)

Use of direct audio input (DAI), which enables a direct connection of the hearing instruments to items such as television, radio, and remote microphones, may increase speech understanding for some individuals. The sound source is connected to the hearing instruments by a cable or a wireless FM system to the audio boot. This accessory connects to the bottom of the hearing instruments, and once properly clicked into place, the hearing instruments switch to DAI automatically.

Connecting/Disconnecting audio boots

Connecting audio boots

1. Align the tip of the audio boot with the groove just above the battery compartment and below the model number.
2. Once in place, move the boot in the direction of the battery compartment.
3. Gently click the audio boot onto the hearing instrument.

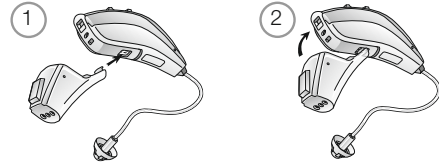

Disconnecting audio boots

4. Press and hold the button on the front side of the audio boot.
5. Gently remove the audio boot from the hearing instrument.

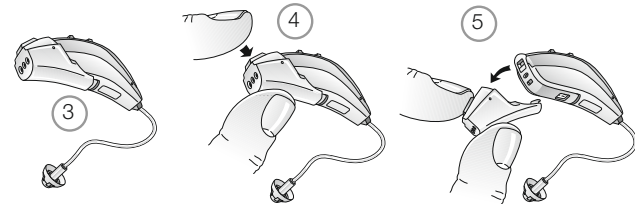



Care and maintenance

Please follow the following instructions to prolong the durability of your hearing instruments:

1. Keep your hearing instrument clean and dry. Wipe the case with a soft cloth or tissue after use to remove grease or moisture. Do not use water or solvents, as these can damage the hearing instrument(s).
2. Never immerse hearing instruments in water or other liquids, as liquids may cause permanent damage to the hearing instruments.
3. Avoid rough handling of hearing instruments or dropping them on hard surfaces or floors.
4. Do not leave hearing instruments in or near direct heat or sunlight, such as in a hot, parked car, as excessive heat can cause damage or deform the casing.
5. Do not wear your instrument while showering, swimming, in heavy rain or in a moist atmosphere such as a steam bath or sauna.
6. If your instrument does get wet, or if it has been exposed to high humidity or perspiration, it should be left to dry out overnight with the battery out and the battery compartment open. It is also a good idea to put the instrument and battery in a sealed container together with a drying agent (desiccator) overnight. Do not use the instrument until it is completely dry. Consult your hearing care professional as to which drying agent to use.
7. Remove your hearing instrument when applying such things as cosmetics, perfume, aftershave, hair spray, and suntan lotion. These might get into the instrument and cause damage.



Daily maintenance

It is important to keep your hearing instrument clean and dry. On a daily basis, clean the hearing instruments using a soft cloth or tissue.

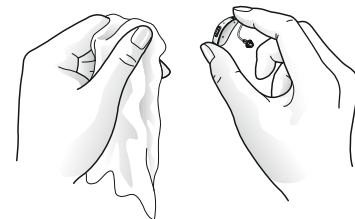

The receiver tube

The receiver tube contains the wiring to the receiver which delivers the sound to the ear canal. It is important that the receiver tube and the receiver dome/RIE mold fits correctly in your ear. If the receiver tube or the receiver dome/RIE mold irritates your ear in any way and prevents you from wearing your hearing instrument, please contact your hearing care professional. You should never attempt to modify the shape of the receiver tube yourself. The receiver tube and the receiver dome/RIE mold should be cleaned regularly. Please see instructions in the next section.



Cleaning the receiver tubes and domes

The receiver tube and the receiver dome should be cleaned regularly. Use a damp cloth to clean the receiver tube and receiver dome on the outside. Do not use water when you are cleaning the receiver tubes or the receiver domes. This process is also used to clean the UP receiver mold. Please see instruction on page 29 for how to change the wax guard filter.



Cleaning RIE or molds (does not apply for Ultra Power molds)

1. Separate the mold from the receiver tube.
2. Clean the RIE mold using a mild soap, and rinse with lukewarm water.
3. After cleaning, dry RIE molds thoroughly and remove any residual water and debris utilising an air bulb.

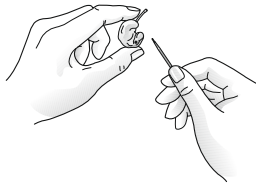

Changing wax guard for receiver tube

For changing Cerustop (white) wax filters, the following steps are needed:

1. To remove the old wax guard, insert the removal side of the wax guard tool into the used wax guard so that the shaft of the tool is touching the rim of the wax guard. Slowly pull the wax guard straight out.
2. To insert the new wax guard, gently press the replacement side of the wax guard tool straight into the hole of the sound outlet until the outer ring lies flush with the outside of the receiver. Pull the tool straight out -the new wax guard will remain in place.

How to apply domes

It is recommended that your hearing care professional change domes, as incorrect dome replacement could result in injury.

ReSound standard domes

1. Push the new dome over the receiver.
2. Make sure that the new dome is properly and securely mounted.

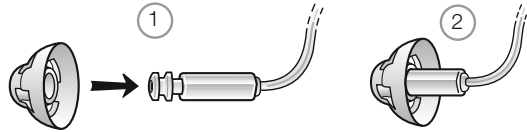

ReSound tulip domes

Tulip domes are mounted in a similar manner to standard domes, but a few extra steps are required. Tulip domes consist of two “petals”. It is important to note that the largest petal is the outermost petal. To ensure this:

1. Push the largest petal away from the receiver tube using a finger. This bends the petal forward.
2. Then push the largest “petal” back, and it will be placed on top of the smaller petal.

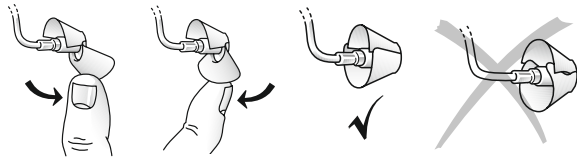

Using ReSound hearing instruments with smart phone apps

i *Intended use of smart phone apps:*

GN ReSound smart phone apps are intended to be used with GN ReSound wireless hearing aids. GN ReSound smart phone apps send and receive signals from the GN ReSound wireless hearing aids via smart phones for which the apps have been developed.

Use with smart phone apps:

- Notifications of app updates should not be disabled, and it is recommended that the user installs all updates to ensure that the app will function correctly and will be kept up to date.
- The app must only be used with GN ReSound devices for which it is intended, and GN ReSound take no responsibility if the app is used with other devices.
- If you would like a printed version of the user guide for a smart phone app please consult customer support or our website to obtain a printed user guide.



General precautions

1. When wireless function is activated, the device uses low-powered digitally coded transmissions in order to communicate with other wireless devices. Although unlikely, nearby electronic devices may be affected. In that case, move the hearing instrument away from the affected electronic device.
2. When using wireless functionality and the devices are affected by electromagnetic interference, move away from the source.
3. Use only original GN ReSound consumables e.g. tubes and domes.
4. Never attempt to modify the shape of the hearing instrument, earmolds, or tubing yourself.
5. Only connect ReSound hearing instruments to ReSound accessories intended and qualified to be used with ReSound hearing instruments.



General warnings

1. Special care should be exercised in selecting and fitting a hearing instrument(s) who's maximum sound pressure level exceeds 132 dB SPL (with an IEC 60711:1981 occluded ear simulator), because there may be a risk of impairing the remaining hearing of the hearing instrument user
2. Consult a hearing care professional if you discover a foreign object in your ear canal, if you experience skin irritation, or if excessive ear wax accumulates with the use of the hearing instrument.
3. Different types of radiation, from e.g. NMR, MRI, or CT scanners, may damage hearing instruments. It is recommended not to wear hearing instruments during these or other similar procedures. Other types of radiation, such as burglar alarms, room surveillance systems, radio equipment, mobile telephones, contain less energy and will not damage hearing instruments. However, they have the potential to momentarily affect the sound quality or temporarily create strange sounds from hearing instruments.
4. Do not wear hearing instruments in mines, oil fields, or other explosive areas unless those areas are certified for hearing instrument use.

5. Do not allow others to use your hearing instruments. This may cause damage to the hearing instruments or to the hearing of the other individual.
6. Instrument usage by children or mentally challenged persons should be supervised at all times to ensure their safety. The hearing instrument contains small parts that could be swallowed by children. Please be mindful not to leave children unsupervised with this hearing instrument.
7. Hearing instruments should be used only as prescribed by your hearing care professional. Incorrect use may result in hearing loss.
8. If device is broken, do not use.
9. When boarding flights remember to deactivate the wireless functionality. Turn off your wireless functionality by using the flight mode in areas where radio frequency emission is prohibited.
10. External devices connected to the electrical input must be safe according to the requirements of IEC 60601-1-1, IEC 60065, or IEC 60950-1, as appropriate (wired connection, f.ex. HI-PRO), SpeedLink).



Note:

- * ReSound wireless devices operate in the frequency range of 2.4 GHz - 2.48 GHz.
- * ReSound wireless devices include a RF transmitter that operates in the range of 2.4 GHz - 2.48 GHz.
- * Nominal RF output power transmitted is 0 dBm.
- * For use of wireless functionality only use ReSound Unite accessories. For further guidance regarding e.g. pairing, please refer to the user guide of the relevant ReSound Unite accessory.

Tinnitus Sound Generator (TSG) module

Intended use for the TSG module

Your ReSound hearing instruments may also include the Tinnitus Sound Generator function, a tool for generating sounds to be used in tinnitus management programs to relieve suffering from tinnitus.

The Tinnitus Sound Generator can generate sounds adjusted to the specific therapeutic needs and your personal preference as determined by your doctor, audiologist, or hearing healthcare professional. Depending on the selected hearing instrument program and the environment you are in, you will sometimes hear the therapeutic sound resembling a continuous or fluctuating whistling.

User instructions for the TSG module

Description of the device

The Tinnitus Sound Generator (TSG) Module is a software tool that generates sounds to be used in tinnitus management programs to relieve suffering from tinnitus.

Explanation of how the device functions

The TSG module is a frequency and amplitude shaped white-noise generator. Noise signal level and frequency characteristics can be adjusted to the specific therapeutic needs as determined by your doctor, audiologist or hearing healthcare professional.

Your doctor, audiologist or hearing healthcare professional can modulate the generated noise with the purpose of making it more pleasant. The noise can then resemble, for example, crashing waves on a shore. Modulation level and speed can also be configured to your likes and needs. An additional feature can be enabled by your hearing healthcare professional that allows you to select predefined sounds that simulate sounds from nature, such as breaking waves or running water.

If you have two wireless hearing aids that support ear to ear synchronization this functionality can be enabled by your hearing healthcare professional. This will cause the Tinnitus Sound Generator to synchronize the sound in both hearing aids.

If your tinnitus troubles you only in quiet environments, your doctor, audiologist or hearing healthcare professional can set the TSG Module so that it becomes audible exclusively in such surroundings. The overall sound level can be adjusted via an optional volume control. Your doctor, audiologist or hearing healthcare professional will review with you the need for having such a control. For hearing aids where ear to ear synchronization is enabled your hearing healthcare professional can also enable environmental monitoring synchronization so that the TSG noise level is automatically adjusted simultaneously in both hearing aids dependent on the background sound level. Additionally if the hearing aid has a volume control then the background noise level monitored by the hearing aid and the volume control can be used simultaneously to adjust the generated noise level in both hearing aids.

TSG volume control

The sound generator is set to a specific loudness level by the hearing healthcare professional. When switching the sound generator on, the volume will have this optimal setting. Therefore, it might not be necessary to control the volume (loudness) manually. However, the volume control provides the ability to adjust the volume, or amount of stimulus, to the liking of the user.

Using TSG with smart phone apps

The tinnitus sound generator control via hearing aid push buttons can be enhanced with wireless control from a TSG control app on a smart phone or mobile device. This functionality is available in supported hearing aids when a hearing healthcare professional has enabled the TSG functionality during fitting of the hearing aid.

To use smart phone apps the hearing aid must be connected with the smart phone or mobile device.

The scientific concepts that form the basis for the device

The TSG Module provides sound enrichment with the aim of surrounding the tinnitus sound with a neutral sound which is easily ignored. Sound enrichment is an important component of most approaches to tinnitus management, such as Tinnitus Retraining Therapy (TRT). To assist habituation to tinnitus, tinnitus needs to be audible. The ideal level of the TSG module, therefore, should be set so that it starts to blend with the tinnitus, and so that you can hear both your tinnitus as well as the sound used.

In a majority of instances, the TSG module can also be set to mask the tinnitus sound, so to provide temporary relief by introducing a more pleasant and controllable sound source.

Technical Specifications

Audio signal technology

Digital

Available sounds

White noise signal which can be shaped with the following configurations:

The white noise signal can be modulated in amplitude with an attenuation depth of up to 14dB.

High-pass filter	Low-pass filter
500 Hz	2000 Hz
750 Hz	3000 Hz
1000 Hz	4000 Hz
1500 Hz	5000 Hz
2000 Hz	6000 Hz



TSG warnings

- Sound generators can be dangerous if improperly used.
- Sound generators should be used only as advised by your doctor, audiologist, or hearing healthcare professional.
- Sound generators are not toys and should be kept out of reach of anyone who might cause themselves injury (especially children and pets).



TSG precautions

- Should the user develop any side effects from using the sound generator, such as dizziness, nausea, headaches, perceived decrease in auditory function or increase in tinnitus perception, the user should discontinue use of the sound generator and seek medical evaluation.
- Children and physically or mentally challenged users will require guardian supervision while wearing the TSG hearing instrument.
- The volume control is an optional feature in the TSG module used for adjusting the sound generator output level. To prevent unintended usage by pediatric or physically or mentally challenged users, the volume control must, if enabled, be configured to only provide a decrease of the sound generator output level.



TSG warning to hearing healthcare professionals

A hearing healthcare professional should advise a prospective sound generator user to consult promptly with a licensed physician (preferably an ear specialist) before getting a sound generator if the hearing healthcare professional determines through inquiry, actual observation, or review of any other available information concerning the prospective user that the prospective user has any of the following conditions:

- (i) Visible congenital or traumatic deformity of the ear.
- (ii) History of active drainage from the ear within the previous 90 days.
- (iii) History of sudden or rapidly progressive hearing loss within the previous 90 days.
- (iv) Acute or chronic dizziness.
- (v) Unilateral hearing loss of sudden or recent onset within the previous 90 days.
- (vi) Audiometric air-bone gap equal to or greater than 15dB at 500 hertz (Hz), 1000 Hz, and 2000 Hz.
- (vii) Visible evidence of significant cerumen accumulation or a foreign body in the ear canal.
- (viii) Pain or discomfort in the ear.



CAUTION: The maximum output of the sound generator falls into the range that can cause hearing loss according to OSHA regulations. In accordance with NIOSH recommendations the user should not use the sound generator for more than eight (8) hours a day when this is set to a level of 85db SPL or above. When the sound generator is set to levels of 90db SPL or above the user should not use the sound generator for more than two (2) hours per day. In no case should the sound generator be worn at uncomfortable levels.



Battery warning information

Batteries, although very small, contain dangerous substances, and should be disposed of carefully. This is for the safety of you and the environment. Please note:

1. Do not attempt to recharge batteries (Zinc Air) which are not specifically designated as rechargeable because they may leak or explode.
2. DO NOT attempt to dispose of batteries by burning them. Used batteries are harmful to the environment. Please dispose of them according to local regulations or return them to your hearing care practitioner.
3. DO NOT place batteries in your mouth. Consult a physician immediately if a battery has been swallowed, as they can be harmful to your health.
4. Keep batteries away from pets, children and mentally challenged persons.
5. Remove the batteries to prevent leakage when the hearing instruments are not in use for an extended period of time.



Hearing instrument expectations

A hearing instrument will not restore normal hearing and will not prevent or improve a hearing impairment resulting from organic conditions. Consistent use of the hearing instrument is recommended. In most cases, infrequent use does not permit you to attain full benefit from it.

The use of a hearing instrument is only part of hearing rehabilitation and may need to be supplemented by auditory training and instructions in lip-reading.



Warning to hearing aid dispensers (US Only)

A hearing aid dispenser should advise a prospective hearing aid user to consult promptly with a licensed physician (preferably an ear specialist) before dispensing a hearing aid if the hearing aid dispenser determines through inquiry, actual observation, or review of any other available information concerning the prospective user, that the prospective user has any of the following conditions:

- (i) Visible congenital or traumatic deformity of the ear.
- (ii) History of active drainage from the ear within the previous 90 days.
- (iii) History of sudden or rapidly progressive hearing loss within the previous 90 days.
- (iv) Acute or chronic dizziness.
- (v) Unilateral hearing loss of sudden or recent onset within the previous 90 days.
- (vi) Audiometric air-bone gap equal to or greater than 15 decibels at 500 hertz (Hz), 1,000 Hz, and 2,000 Hz.
- (vii) Visible evidence of significant cerumen accumulation or a foreign body in the ear canal.
- (viii) Pain or discomfort in the ear.

Important notice for prospective hearing aid users (US Only)

Good health practice requires that a person with a hearing loss have a medical evaluation by a licensed physician (preferably a physician who specializes in diseases of the ear) before purchasing a hearing aid. Licensed physicians who specialize in diseases of the ear are often referred to as otolaryngologists, otologists or otorhinolaryngologists. The purpose of medical evaluation is to assure that all medically treatable conditions that may affect hearing are identified and treated before the hearing aid is purchased.

Following the medical evaluation, the physician will give you a written statement that states that your hearing loss has been medically evaluated and that you may be considered a candidate for a hearing aid. The

physician will refer you to an audiologist or a hearing aid dispenser, as appropriate, for a hearing aid evaluation. The audiologist or hearing aid dispenser will conduct a hearing aid evaluation to assess your ability to hear with and without a hearing aid. The hearing aid evaluation will enable the audiologist or dispenser to select and fit a hearing aid to your individual needs. If you have reservations about your ability to adapt to amplification, you should inquire about the availability of a trial-rental or purchase-option program. Many hearing aid dispensers now offer programs that permit you to wear a hearing aid for a period of time for a nominal fee after which you may decide if you want to purchase the hearing aid.

Federal law restricts the sale of hearing aids to those individuals who have obtained a medical evaluation from a licensed physician. Federal law permits a fully informed adult to sign a waiver statement declining the medical evaluation for religious or personal beliefs that preclude consultation with a physician. The exercise of such a waiver is not in your best health interest and its use is strongly discouraged.

Children with hearing loss (US Only)

In addition to seeing a physician for a medical evaluation, a child with a hearing loss should be directed to an audiologist for evaluation and rehabilitation since hearing loss may cause problems in language development and the educational and social growth of a child. An audiologist is qualified by training and experience to assist in the evaluation and rehabilitation of a child with a hearing loss.

Troubleshooting Guide

SYMPTOM	CAUSE	POSSIBLE REMEDY
No sound	Not turned on	Turn on by closing the battery door
	Dead battery	Replace battery
	Battery door will not close	Insert battery properly
	Blocked RIE mold or tube	Clean RIE mold or tube
	Blocked wax filter	Replace wax filter or consult your hearing care professional
Not loud enough	Incorrect RIE mold placement	Reinsert RIE mold
	Blocked RIE mold or dome	Clean RIE mold, replace dome, replace filter
	Change in hearing sensitivity	Consult your hearing care professional
	Excessive ear wax	Consult your hearing care professional
	Volume set too low	Consult your hearing care professional

Troubleshooting Guide

SYMPTOM	CAUSE	POSSIBLE REMEDY
Excessive whistling / feedback	Incorrect RIE mold placement	Re-insert RIE mold carefully
	Incorrect dome placement	Re-insert dome
	Excessive ear wax	Consult your hearing care professional
	Feedback control may need adjustment	Consult your hearing care professional
	RIE mold tubing worn or damaged	Consult your hearing care professional
	Hearing instrument settings not optimal	Consult your hearing care professional
Sound distorted / not clear	Weak battery	Replace battery
	Improper RIE mold or dome fit	Consult your hearing care professional
	Hearing instrument damaged	Consult your hearing care professional
	Hearing instrument settings not optimal	Consult your hearing care professional
Wireless does not work	Possible Root Cause - Device is in flight mode	Open and close the battery compartment once. Wireless will reactivate 10 seconds later. (If Root Cause is device in flight mode)

Technical data

RIE - LP receiver

Models: LS962-DRW, LS762-DRW, LS562-DRW
LS961-DRW, LS761-DRW, LS561-DRW

Reference test gain (60 dB SPL input)	HFA	31	dB
Full-on gain (50 dB SPL Input)	Max	52	dB
	HFA	43	dB
Maximum output (90 dB SPL input)	Max	113	dB SPL
	HFA	108	dB SPL
Total harmonic distortion	500 Hz	0.3	%
	800 Hz	0.5	%
	1600 Hz	0.7	%
Telecoil sensitivity (SPLIV @ 31,6 mA/m)		90	dB SPL
Equivalent input noise (w/o noise reduction)		23	dB SPL
Frequency range (DIN 45605)		100–7060	Hz
Current drain (in test mode)		1.3	mA

Note: Telecoil sensitivity only applicable for 62 RIE models

Data in accordance with ANSI S3.22–2009 and IEC 60118-7;
Supply Voltage 1.3 V, 2cc coupler

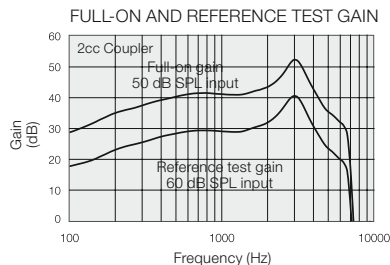
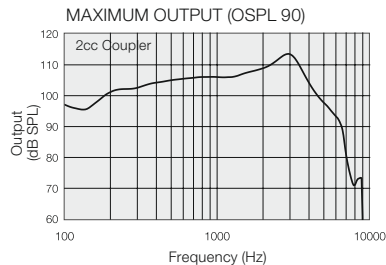

RIE—MP receiver

Models: LS962-DRW, LS762-DRW, LS562-DRW
LS961-DRW, LS761-DRW, LS561-DRW

Reference test gain (60 dB SPL input)	HFA	37	dB
Full-on gain (50 dB SPL Input)	Max	58	dB
	HFA	51	dB
Maximum output (90 dB SPL input)	Max	116	dB SPL
	HFA	114	dB SPL
Total harmonic distortion	500 Hz	0.5	%
	800 Hz	0.6	%
	1600 Hz	1.2	%
Telecoil sensitivity (SPLIV @ 31.6 mA/m)		96	dB SPL
Equivalent input noise (w/o noise reduction)		23	dB SPL
Frequency range (DIN 45605)		100–7000	Hz
Current drain (in test mode)		1.3	mA

Note: Telecoil sensitivity only applicable for 62 RIE models

Data in accordance with ANSI S3.22–2009 and IEC 60118-7;
Supply Voltage 1.3 V, 2cc coupler

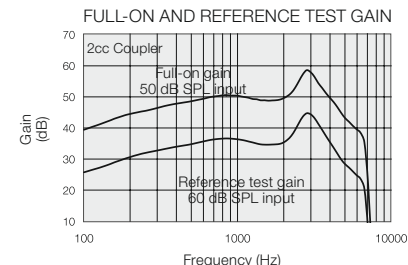
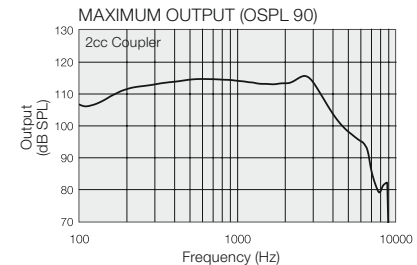

RIE—HP receiver

Models: LS962-DRW, LS762-DRW, LS562-DRW
LS961-DRW, LS761-DRW, LS561-DRW

Reference test gain (60 dB SPL input)	HFA	42	dB
Full-on gain (50 dB SPL Input)	Max	65	dB
	HFA	56	dB
Maximum output (90 dB SPL input)	Max	122	dB SPL
	HFA	118	dB SPL
Total harmonic distortion	500 Hz	0.6	%
	800 Hz	1.2	%
	1600 Hz	0.7	%
Telecoil sensitivity (SPLIV @ 31.6 mA/m)		101	dB SPL
Equivalent input noise (w/o noise reduction)		23	dB SPL
Frequency range (DIN 45605)		100–6030	Hz
Current drain (in test mode)		1.3	mA

Note: Telecoil sensitivity only applicable for 62 RIE models

Data in accordance with ANSI S3.22–2009 and IEC 60118-7;
Supply Voltage 1.3 V, 2cc coupler

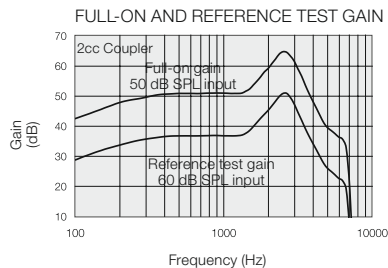
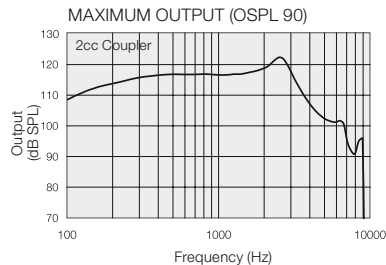

RIE—UP receiver

Models: LS962-DRW, LS762-DRW, LS562-DRW
LS961-DRW, LS761-DRW, LS561-DRW

Reference test gain (60 dB SPL input)	HFA	47	dB
Full-on gain (50 dB SPL Input)	Max	75	dB
	HFA	64	dB
Maximum output (90 dB SPL input)	Max	129	dB SPL
	HFA	124	dB SPL
Total harmonic distortion	500 Hz	1.3	%
	800 Hz	2.1	%
	1600 Hz	0.1	%
Telecoil sensitivity (SPLIV @ 31.6 mA/m)		107	dB SPL
Equivalent input noise (w/o noise reduction)		23	dB SPL
Frequency range (DIN 45605)		100–4910	Hz
Current drain (in test mode)		1.2	mA

Note: Telecoil sensitivity only applicable for 62 RIE models

Data in accordance with ANSI S3.22–2009 and IEC 60118-7;
Supply Voltage 1.3 V, 2cc coupler

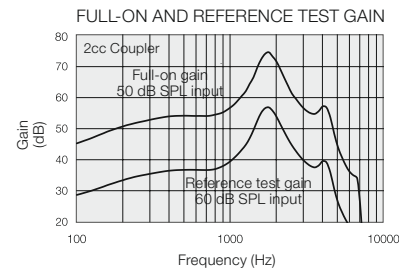
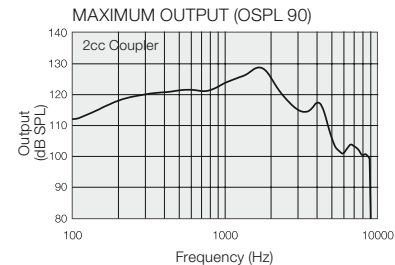

RIE—LP receiver

Models: EY362-DRW LP

Reference test gain (60 dB SPL input)	HFA	30	dB
Full-on gain (50 dB SPL Input)	Max	51	dB
	HFA	42	dB
Maximum output (90 dB SPL input)	Max	113	dB SPL
	HFA	107	dB SPL
Total harmonic distortion	500 Hz	0.5	%
	800 Hz	0.4	%
	1600 Hz	0.6	%
Telecoil sensitivity (SPLIV @ 31.6 mA/m)		92	dB SPL
Equivalent input noise (w/o noise reduction)		23	dB SPL
Frequency range (DIN 45605)		100 - 7100	Hz
Current drain (in test mode)		1.33	mA

Note: Telecoil sensitivity only applicable for 62 RIE models

Data in accordance with ANSI S3.22–2009 and IEC 60118-7;
Supply Voltage 1.3 V, 2cc coupler

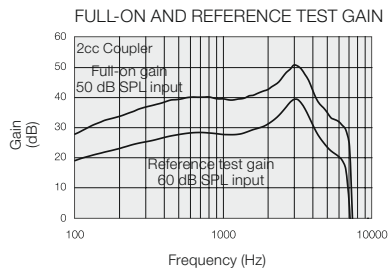
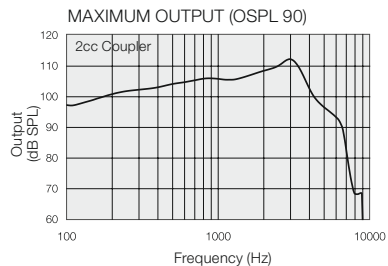

RIE—MP receiver

Models: EY362-DRW MP

Reference test gain (60 dB SPL input)	HFA	35	dB
Full-on gain (50 dB SPL Input)	Max	57	dB
	HFA	49	dB
Maximum output (90 dB SPL input)	Max	116	dB SPL
	HFA	113	dB SPL
Total harmonic distortion	500 Hz	0.5	%
	800 Hz	0.7	%
	1600 Hz	1.1	%
Telecoil sensitivity (SPLIV @ 31.6 mA/m)		96	dB SPL
Equivalent input noise (w/o noise reduction)		23	dB SPL
Frequency range (DIN 45605)		100 - 7040	Hz
Current drain (in test mode)		1.23	mA

Note: Telecoil sensitivity only applicable for 62 RIE models

Data in accordance with ANSI S3.22–2009 and IEC 60118-7;
Supply Voltage 1.3 V, 2cc coupler

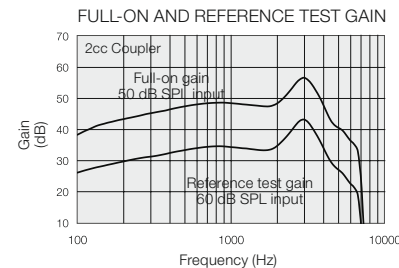
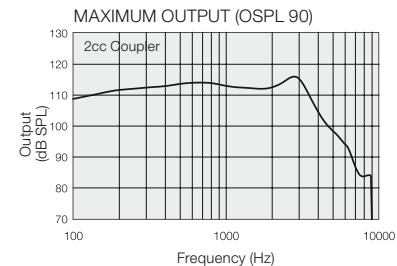

RIE—HP receiver

Models: EY362-DRW HP

Reference test gain (60 dB SPL input)	HFA	41	dB
Full-on gain (50 dB SPL Input)	Max	64	dB
	HFA	55	dB
Maximum output (90 dB SPL input)	Max	122	dB SPL
	HFA	118	dB SPL
Total harmonic distortion	500 Hz	0.6	%
	800 Hz	1.0	%
	1600 Hz	0.5	%
Telecoil sensitivity (SPLIV @ 31.6 mA/m)		102	dB SPL
Equivalent input noise (w/o noise reduction)		23	dB SPL
Frequency range (DIN 45605)		100 - 6890	Hz
Current drain (in test mode)		1.23	mA

Note: Telecoil sensitivity only applicable for 62 RIE models

Data in accordance with ANSI S3.22–2009 and IEC 60118-7;
Supply Voltage 1.3 V, 2cc coupler

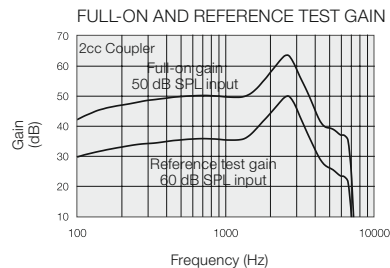
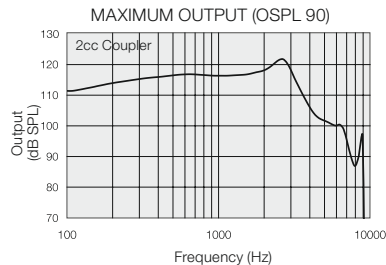

RIE—UP receiver

Models: EY362-DRW UP

Reference test gain (60 dB SPL input)	HFA	47	dB
Full-on gain (50 dB SPL Input)	Max	73	dB
	HFA	63	dB
Maximum output (90 dB SPL input)	Max	129	dB SPL
	HFA	124	dB SPL
Total harmonic distortion	500 Hz	1.0	%
	800 Hz	1.5	%
	1600 Hz	0.1	%
Telecoil sensitivity (SPLIV @ 31.6 mA/m)		108	dB SPL
Equivalent input noise (w/o noise reduction)		21	dB SPL
Frequency range (DIN 45605)		100 - 4940	Hz
Current drain (in test mode)		1.22	mA

Note: Telecoil sensitivity only applicable for 62 RIE models

Data in accordance with ANSI S3.22–2009 and IEC 60118-7;
Supply Voltage 1.3 V, 2cc coupler

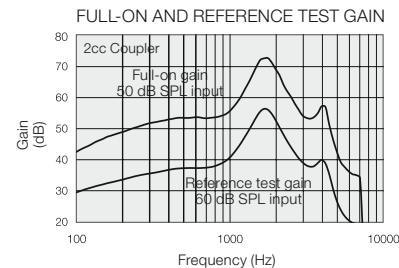
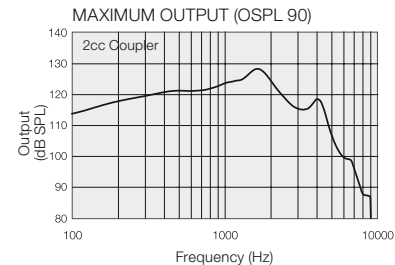

Warranty and repairs

ReSound provides a warranty on hearing instruments in the event of defects in workmanship or materials, as described in applicable warranty documentation. In its service policy, ReSound pledges to secure functionality at least equivalent to the original hearing instrument. As a signatory to the United Nations Global Compact initiative, ReSound is committed to doing this in line with environment-friendly best practices. Hearing instruments therefore, at ReSound's discretion, may be replaced by new products or products manufactured from new or serviceable used parts, or repaired using new or refurbished replacement parts. The warranty period of hearing instruments is designated on your warranty card, which is provided by your hearing care professional.

For hearing instruments that require service, please contact your hearing care professional for assistance. ReSound hearing instruments that malfunction must be repaired by a qualified technician. Do not attempt to open the case of hearing instruments, as this will invalidate the warranty.

Temperature test, transport and storage information

GN ReSound Hearing Instruments are subjected to various tests in temperature and damp heating cycling between -25 °C and +70 °C according to internal and industry standards. During transport or storage, the temperature should not exceed the limit values of -20 °C to 60 °C and relative humidity of 90% RH, non condensing (for limited time). The air pressure between 500 and 1100 hPa is appropriate.

© 2018 GN Hearing A/S. All rights reserved. ReSound is a trademark of GN Hearing A/S. Apple, the Apple logo, iPhone, iPad, iPod touch are trademarks of Apple Inc., registered in the U.S. and other countries.

Be aware of information marked with the warning symbol



WARNING points out a situation that could lead to serious injuries,
CAUTION indicates a situation that could lead to minor and moderate injuries



Advice and tips on how to handle your hearing instrument better.



Equipment includes RF transmitter

ReSound LiNX² is compatible with iPhone 8 Plus, iPhone 8, iPhone 7 Plus, iPhone 7, iPhone 6s Plus, iPhone 6s, iPhone 6 Plus, iPhone 6, iPhone SE, iPhone 5s, iPhone 5c, iPhone 5, iPad Pro (10.5-inch), iPad Pro (12.9-inch), iPad Pro (9.7-inch), iPad Air 2, iPad Air, iPad mini 4, iPad mini 3, iPad mini 2, iPad mini, iPad (5th generation), iPad (4th generation), iPod touch (6th generation) and iPod touch (5th generation) using iOS 8.0 or later. Apple, the Apple logo, iPhone, iPad Pro, iPad Air, iPad mini, iPad and iPod touch are trademarks of Apple Inc., registered in the U.S. and other countries.



“Made for iPhone” means that an electronic accessory has been designed to connect specifically to iPhone and has been certified by the developer to meet Apple performance standards. Apple is not responsible for the operation of this device or its compliance with safety and regulatory standards. Please note that the use of this accessory with iPhone may affect wireless performance.



Please ask your local hearing care professional concerning disposal of your hearing instrument

Manufacturer according to
EU Medical Device
Directive 93/42/EEC:

GN ReSound A/S
Lautrupbjerg 7
DK-2750 Ballerup
Denmark
Tel.: +45 4575 1111
resound.com

CVR no. 55082715

Manufacturer according
to FDA:

GN ReSound North America
8001 E Bloomington Freeway
Bloomington, MN 55420
USA
1-888-735-4327
resound.com

ReSound Government Services

8001 E Bloomington Freeway
Bloomington, MN 55420
USA
1-800-392-9932
resound.com/veterans

Manufacturer according to
Health Canada:

ReSound Canada
303 Supertest Road
Toronto, ON M3J 2M4
Canada
1-888-737-6863
resound.com



Any issues relating to the EU Medical Device Directive 93/42/EEC or EU Radio
Equipment Directive 2014/53/EU should be directed to GN ReSound A/S.

